

F500WS/NS

1/10 SCALE ELECTRIC FORMULA CAR

SETTING SHEET

Date _____

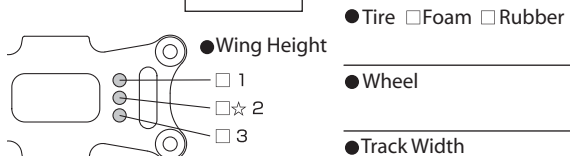
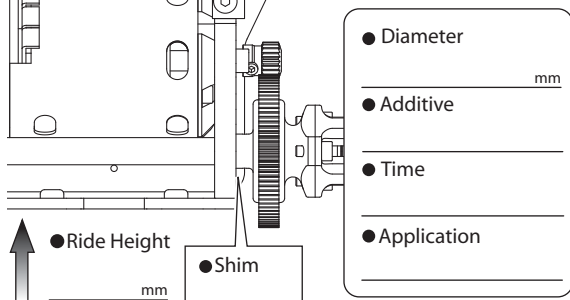
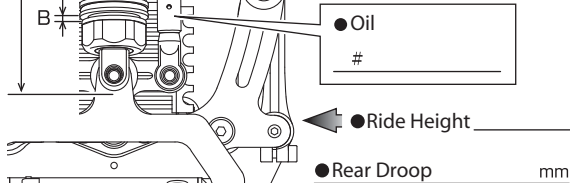
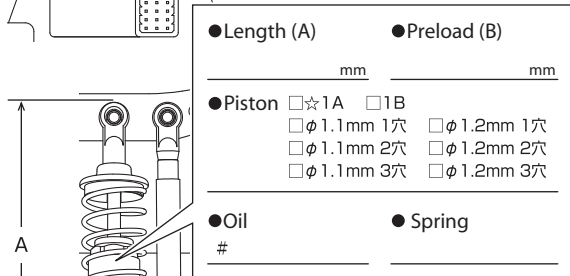
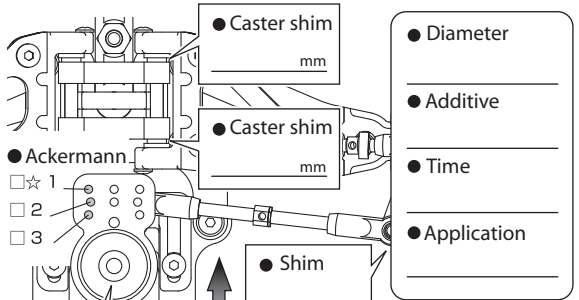
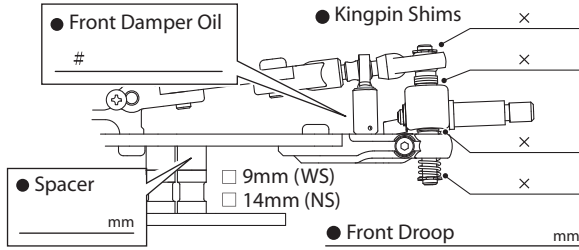

☆ kit setup

mm

● Name _____

● Track / Event _____

Environment □ Indoor □ Outdoor

Surface □ Asphalt □ Carpet □ Bumpy □ Smooth

Traction _____

Low Medium High

Air temp. °C Track temps. °C Humidity %

● Chassis □ WS (200mm) □ NS (180mm)

● Body _____

● Front Wing _____ ● Rear Wing _____



● Front Spring

□ SS φ0.4 (黒)

□ ☆ S φ0.45 (金)

□ MS φ0.5 (黒)

□ M φ0.5 (銀)

□ H φ0.55 (黒)

□ Other ()

● Toe □ Out □ In

● Camber ° _____

● Front Bulkhead Height

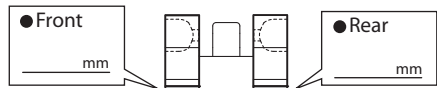

● Side Spring

□ ☆ S (銀) □ M (黒) □ H (銀)

□ Other ()

● Side Spring Preload

● Bearing Holder

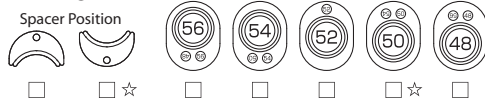

● Ratio Pitch DP Pinion Spur

T T

● Motor

Rotor mm Timing Turns

● Battery

□ 1S

□ Shorty Battery Position □ Front □ Rear

● Result Qualification Final

of Lap Lap time

Memo