

Driver: _____
 Date: _____
 Event: _____
 Track: _____
 Result: _____

Track Conditions

- CRC Black CRC Grey ETS

 Low Medium High
 Small Medium Large
 Smooth Both Bumpy
 Temp: _____ Humidity: _____

Shock

Oil: _____
 Spring: _____
 Length: _____
 Preload: _____

Damper Tube

- 5k 10k 15k 20k

Front Tires

Compound: _____
 Diameter: _____
 Additive: _____
 Soak time: _____

Rear Tires

Compound: _____
 Diameter: _____
 Additive: _____
 Soak time: _____

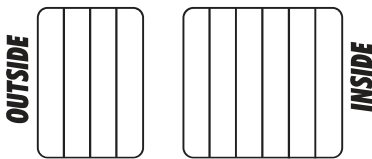

Electronics

Motor: _____
 Timing: _____
 Battery: _____
 ESC: _____
 Ratio: _____

Aerodynamics

Body: _____
 Wings: _____
 Car weight: _____

Suspended Pod: _____
 (Shock length)

Race Ready Pod: _____
 (Shock Preload)

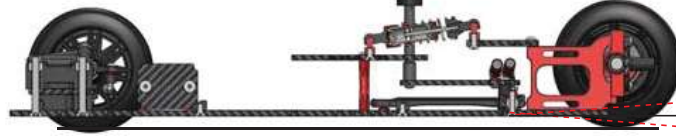

Rear Pod _____

+ Sag (up)
 Chassis Plane
 - Droop (down)

Ride Height - Front: _____ Middle: _____ Rear: _____

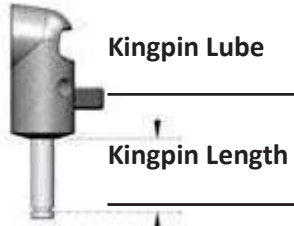

Kingpin Lube _____

Kingpin Length _____

Dynamic Caster Block

- 0° 5° 10°

Camber: _____

Shim under Arm

- .02 .03 .04

Caster

- 2 shims front
 1 shim front
 All shims back

Front Spring

- 45 50 55 60

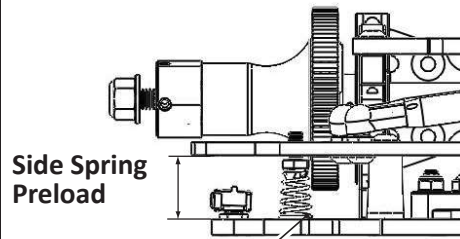

Side Spring Preload

Side Spring

- 45 50 55 60

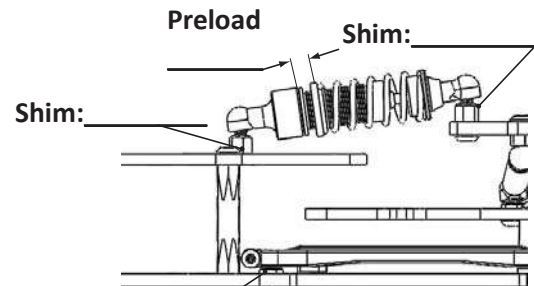

Preload _____

Shim: _____

Shim: _____

Rear Steer - Shim: _____

Servo: _____

Battery Position

- Fwd Inline Back Inline
 Fwd Transverse Back Transverse

Top Deck Position

- 3 2 1

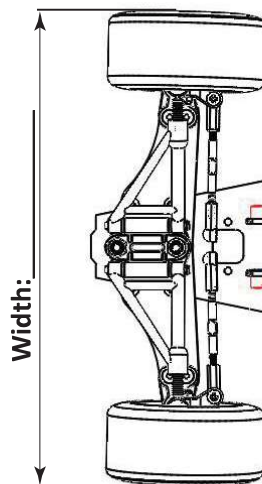

Width: _____

Shock Position

- 4 3 2 1

Tierod Angle

- Swept back
 Swept Forward
 Straight

Chassis

- Stock Carbon
 Z-Flex Carbon

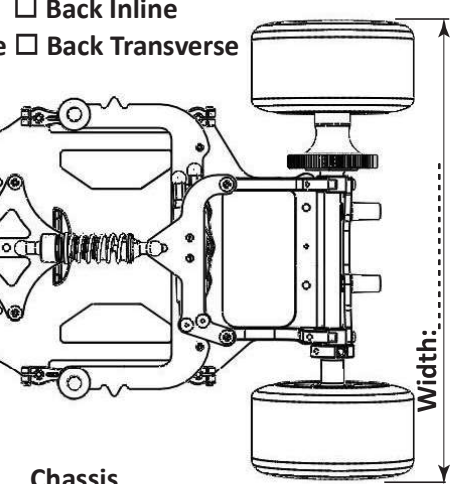

Width: _____

Toe: _____

Rear Wing Position

